

CONF. 790303--2

LA-UR 78-3234

**MASTER**

**TITLE:** MICROPROCESSOR BASED SYSTEM FOR ROLL-DOWN AND ACCELERATION TESTS

**AUTHOR(S):** D. K. Lynn, C. Derouin, and P. Lamar

**SUBMITTED TO:** The Institute of Electrical and Electronics Engineers, Inc., 29th Vehicular Technology Conference, Arlington, Illinois, March 28, 29, & 30, 1979, for presentation and publication.

**NOTICE**  
This report was prepared as an account of work sponsored by the United States Government. Neither the United States nor the United States Department of Energy, nor any of their employees, nor any of their contractors, subcontractors, or their employees, make any warranty, express or implied, or assume any legal liability or responsibility for the accuracy, completeness, or usefulness of any information disclosed herein. This report is disseminated in the public interest and its use is encouraged. It is not to be distributed outside the agency to which it is submitted.

By acceptance of this article, the publisher recognizes that the U.S. Government retains a non-exclusive, royalty-free license to publish or reproduce the published form of this contribution, or to allow others to do so, for U.S. Government purposes.

The Los Alamos Scientific Laboratory requests that the publisher identify this article as work performed under the auspices of the Department of Energy.

  
**Los Alamos**  
**scientific laboratory**  
of the University of California  
LOS ALAMOS, NEW MEXICO 87545

An Affirmative Action/Equal Opportunity Employer

DISTRIBUTION STATEMENT

MICROPROCESSOR-BASED SYSTEM FOR ROLL-DOWN AND ACCELERATION TESTS

D. K. Lynn and C. Derouin  
 Los Alamos Scientific Laboratory  
 P. O. Box 1663  
 Los Alamos, New Mexico 87544

P. Lamar  
 Lamar Instruments 9509125  
 2107 Artesia Blvd.  
 Redondo Beach, California 90277

A microprocessor-based, road-test system for measuring and recording roll-down and acceleration data has been designed and built. The system provides for rapid testing of vehicles, can be operated by a single individual, and allows detailed data acquisition when required. Digital data storage and output capability allows direct exchange of data with other computers or calculators for data analysis and reduction. System input is distance from a fifth wheel and elapsed time. The microcomputer system records time to the nearest 0.01 second, distance to the nearest foot, and calculates velocity to the nearest 0.1 mile per hour. Data can be stored at specified time, distance, and velocity intervals. Current time, distance, and velocity are displayed on a liquid crystal display panel. A printing calculator prints a summary of the run. Detailed data is stored in RAM and is output to magnetic tape at the end of the run. The tapes are used to obtain plots and as input for data reduction programs that calculate rolling friction and aerodynamic drag. The road-test system has been used to test a number of vehicles. In most of the tests one person drove the vehicle and operated the system.

Hardware Configuration

A simplified block diagram of the road-test system is shown in Fig. 1. The primary input to the system is 100 pulses/ft from the fifth wheel. These pulses are divided by 100 for the distance counter and fed to a BCD counter for the velocity calculation. The remaining inputs are provided by two timers and the status switches. The time counter is updated every 10 ms. Velocity is determined by reading the BCD counter every 68 ms. Then

$$v = \frac{N/100}{0.068} \times \frac{60}{88} = \frac{N}{10} \text{ mph} \quad (1)$$

where N is the number of counts.

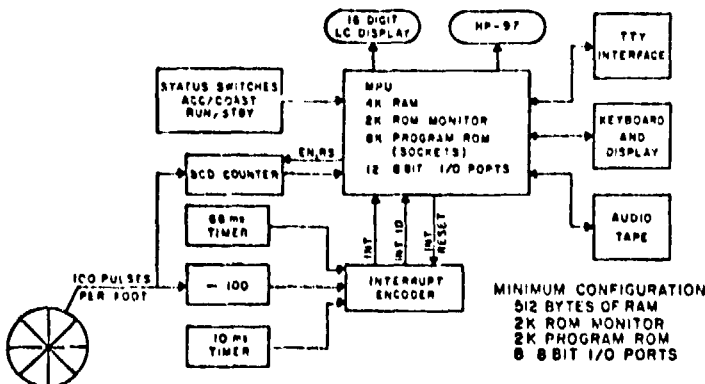

Fig. 1. Simplified diagram of Lamar Instruments road-test system.

The status switches define whether an acceleration or coast-down run is required and whether the system is in the run or standby condition. A coast-down run begins when the run/standby status is changed from standby to run. An acceleration run begins automatically when the foot counter reaches one foot.

The two timers and the foot counter interrupt the microprocessor so that it can update time, distance, or velocity. The timers interrupt at 10- and 68-ms intervals; the foot counter interrupts at

$$T_v = \frac{1}{v} \frac{60}{88} = \frac{0.68}{v} \text{ s} \quad (2)$$

For  $v = 100$  mph, the foot counter interrupts the processor every 6.8 ms and the 3 interrupts occur every 3.82 ms on the average. The external status switches are read during initialization, in the background program, and immediately after each interrupt.

The highest priority is assigned to the 68-ms timer, which is the most critical interrupt. The BCD counter must be disabled, read, reset, then enabled at precise intervals in order to give accurate velocity readings. The disable, read, reset, enable sequence takes 22  $\mu$ s, or about 0.03% of the 68-ms count time. As long as the 10-ms timer (and foot counter) are updated before the next time interval (or foot) occurs, there is no error accumulation in time (or distance).

The system diagram of Fig. 2 includes a more detailed description of the processing unit. The processing unit contains a MOS technology 6502 microprocessor, 4K bytes of read/write memory, sockets for up to 8K bytes of program read-only memory, twelve 8-bit I/O ports, 10 timers, 4 shift registers, and a 2K byte monitor stored in ROM. The road-test system requires 512 bytes of RAM (2K to 4K bytes for detailed data storage), 2K bytes of program ROM, eight 8-bit I/O ports, 3 timers, and the 2K-byte ROM monitor. The remaining capacity can be used for an expanded vehicle instrumentation system.

System output is provided by a 16-digit liquid crystal display and by the printer on an HP-97 printing calculator. The LC display is normally placed on the vehicle dashboard and displays elapsed time, current velocity, and elapsed distance. The HP-97 prints elapsed time, velocity, and elapsed distance at specified times, velocities, and distances. For acceleration runs the printer prints at 10 and 20 s; at each 10-mph interval; and at 100, 300, 500, 500, 1320, and 1400 ft. The print points for coast down are 10, 20, 50, 70, and 90 s; each 10-mph interval, and 100, 500, 1000, 2000, and 5000 ft.

Additional data can be saved in RAM if desired. The data can then be output to tape and/or printed on a data terminal at the end of the run. Currently,

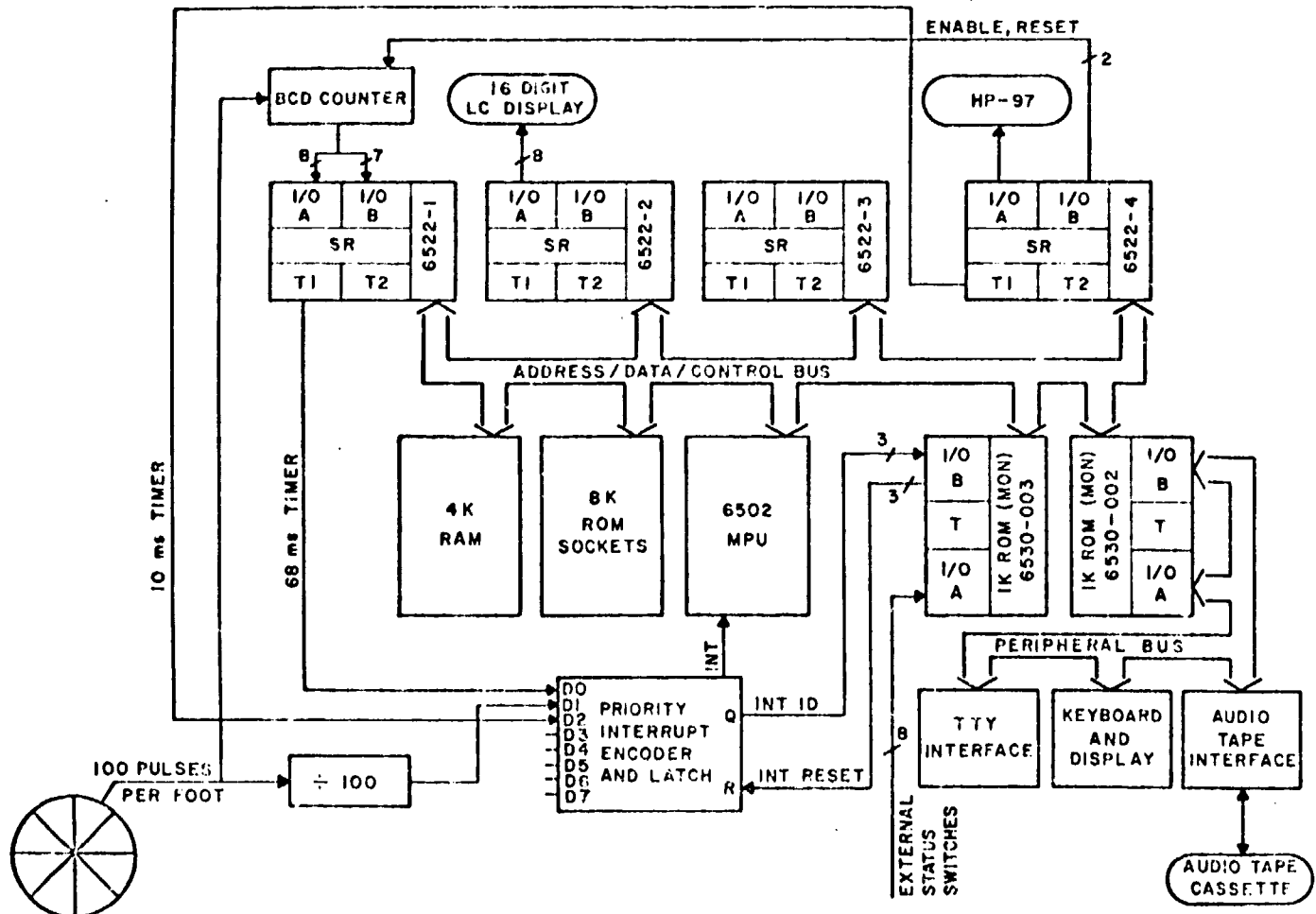

Fig. 2. Lamar Instruments computerized road-test system.

time, velocity, and distance are saved each second and each mile per hour for both acceleration and coast down. In addition, data is saved every 200 ft for acceleration runs and every 500 ft for coast down. For most applications, saving data each second is adequate. Both the print points and the save points are software defined and can be easily changed.

The data stored on tape can be processed by a number of systems. At Los Alamos most of the data was processed by a HP-9820A desk calculator with a 9862A plotter. Some data processing was done with a 6502 microprocessor system and some with a CDC 7600 computer.

The keyboard and display can be used to address memory, enter data, begin execution of a program, reset the system, or interrupt the processor. The display consists of six 7-segment digits to display the address (4 digits) and data (2 digits).

A data terminal can be connected through the TTY interface to enhance the I/O capabilities of the system. Specifically, a TI 733 ASR with a TTY to RS-232C adapter is used, although other TTY 20-mA current loop or RS-232C compatible terminals can be used.

The audio tape is used to enter data and programs into RAM or store them on tape. In addition, the TI 733 ASR can be used for the same purpose except that the tapes are in a digital format compatible with the Los Alamos Central Computing Facility as well as most other data centers.

### Software Description

The major portions of the software are the initialization routine, the background programs that provide output to the LCD and the printer, the interrupt ID routine, and the three interrupt service routines that update velocity, distance, and time.

The turn-on sequence and background programs are shown in Fig. 3. After the processor is initialized, the default print and save values for time, velocity, and distance are loaded from ROM to RAM. Once in RAM, these values can be changed if desired by means of the keyboard. The default values are stored in an erasable PROM and are easily changed if an EPROM programmer is available.

The LCD-output routine updates the display with the current values of elapsed time, velocity, and elapsed distance. The display is updated every half second. If the display is updated too rapidly, readability is reduced. The HP-97 output routine sends data to the HP-97 as long as there is data in the print buffer. Since there is no handshaking with the HP-97, delays are used between output commands. A delay of 120 ms between each data character and a 1.28-second delay between print commands provides reliable operation.

The interrupt identification routine first saves the accumulator and the two index registers, reads the

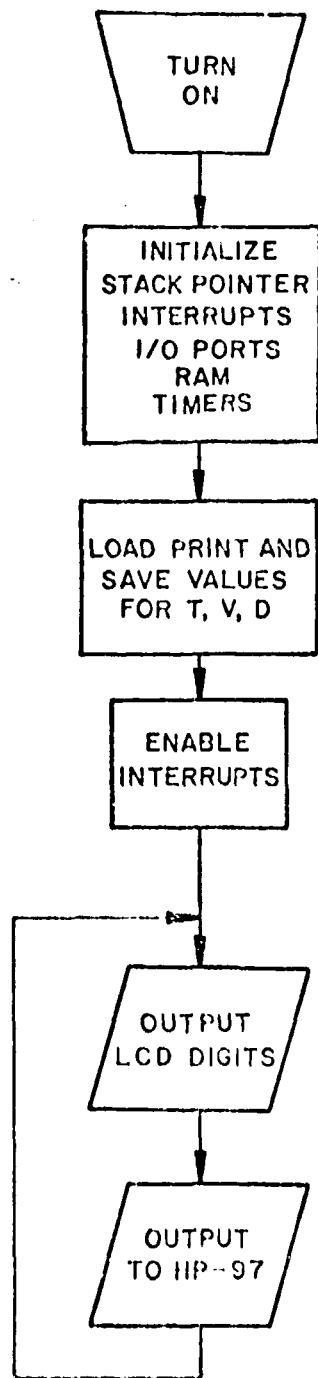

Fig. 3. Initialization and background programs.

external status switches, and reads the priority interrupt encoder. The routine then determines if the interrupt was from the 68-ms timer, the foot counter, or the 10-ms timer and jumps to the velocity distance or time service routine accordingly.

The interrupt service routines update velocity, distance, and time when required. A flow chart of the velocity update routine is shown in Fig. 4. This routine reads the BCD counter, stores the current value of velocity, determines if a run is in progress (system in run and distance greater than 1 ft), saves data if appropriate, resets the mph interrupt flag and returns. The foot and time routines increment and store distance or time when appropriate, reset the interrupt flag, and return to the background program.

The 2K-byte ROM monitor, supplied by MOS Technology, permits input and output through the keyboard and display, a VT compatible data terminal, and an audio tape unit. Use of a TI 733ASR and RS-232C adapter permits I/O from digital tape cassettes. The monitor also allows program execution to be started or stopped from the keyboard or the data terminal.

Some additions to the MOS Technology monitor have been written that provide:

- more convenient display of a memory block on the data terminal,

- move memory block 1 to memory block 2,

- set memory block to a hex number,

- Compare memory block to a hex number,

- Compare memory block 1 to memory block 2, and

- Faster dump of memory block to audio tape.

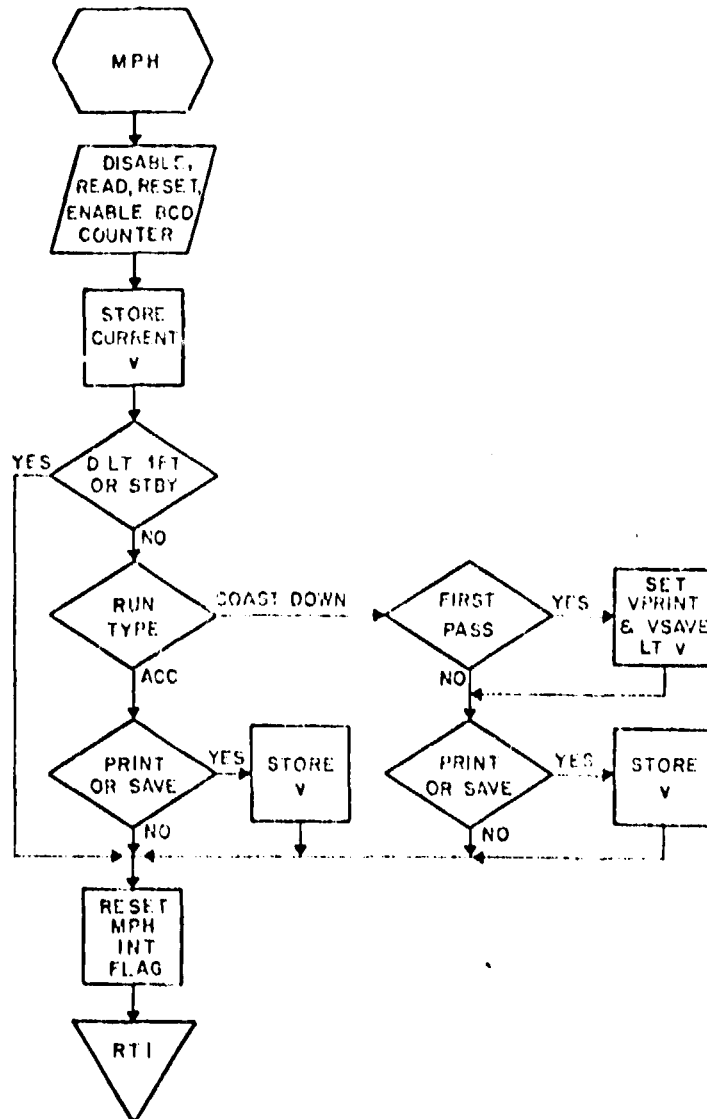

Fig. 4. Velocity update routine.

### Conclusions

The road-test system described provides rapid and detailed acquisition of accurate data from roll-down and acceleration tests. Straight-line vehicle performance is characterized by power at the wheels, rolling friction, and aerodynamic drag plus external factors such as wind and grade. Available power at the wheels can be determined from wide open throttle acceleration tests. Rolling friction and aerodynamic drag can be determined from coast-down tests.

A fuel-cell powered vehicle program at Los Alamos required that the performance of a number of vehicles be characterized. The road-test system was used for this purpose. Since it is microprocessor based, the system is also intended to be used as an expanded data-acquisition system for a fuel-cell powered vehicle.

The first time the system was used, 12 vehicles were tested in 3 days. A total of 103 roll-down and 13 quarter mile acceleration runs were made. In most of the tests one person drove the vehicle and operated the road test system. Data was saved on tape at 1 s and 1 mile per hour intervals. Figures 5 and 6 show acceleration and coast-down plots for v versus t obtained from the tape data for a Volkswagen Rabbit.

The tapes were used as input to a number of data-reduction programs. Most of the data reduction was done on a desk calculator with an ink plotter. Some data processing was also done on a microprocessor system, and some on a Col. 500 computer.

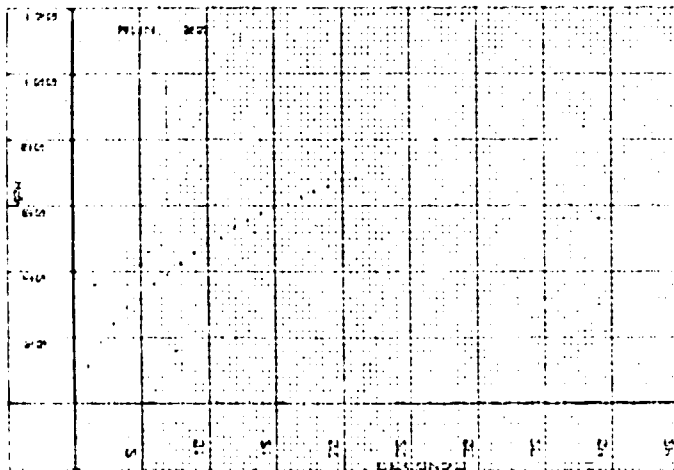

Fig. 5. Volkswagen Rabbit acceleration.

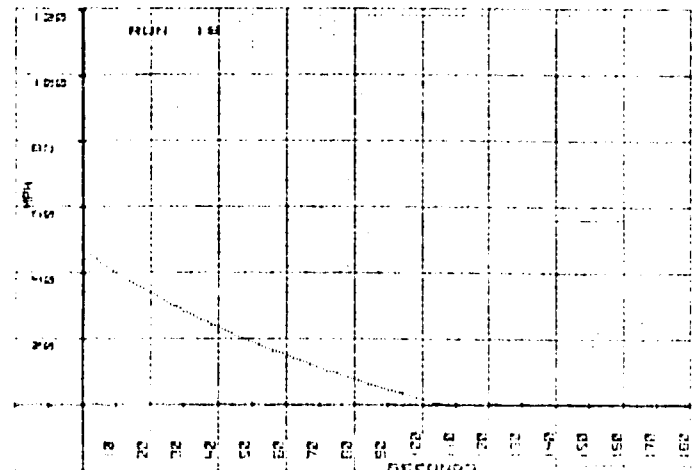

Fig. 6. Volkswagen Rabbit coast down.

### Conclusions

The road-test system described provides rapid and detailed acquisition of acceleration and acceleration tests. Straight-line vehicle performance is characterized by power at the wheels, rolling friction, and aerodynamic drag plus external factors such as wind and grade. Available power at the wheels can be determined from wide open throttle acceleration tests. Rolling friction and aerodynamic drag can be determined from coast-down tests.

A fuel-cell powered vehicle program at Los Alamos required that the performance of a number of vehicles be characterized. The road-test system was used for this purpose. Since it is microprocessor based, the system is also intended to be used as an expanded data-acquisition system for a fuel-cell powered vehicle.

The first time the system was used, 12 vehicles in a total of 100 roll-down and 10 quarter mile acceleration runs were made. In most of the tests one person drove the vehicle and operated the road test system. Data was saved on tape at 1 s and 1 mile per hour intervals. Figures 5 and 6 show acceleration and coast-down plots for v versus t obtained from the tape data for a Volkswagen Rabbit.

The tapes were used as input to a number of data-reduction programs. Most of the data reduction was done on a desk calculator with an ink plotter. Some data processing was also done on a microprocessor system, and some on a CDC 3600 computer.

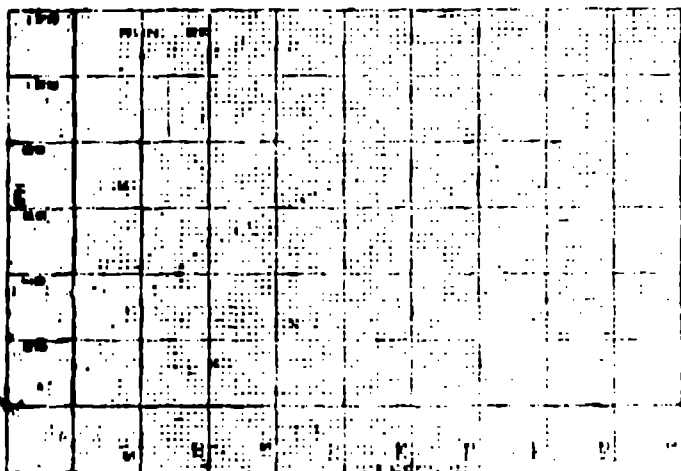

Fig. 5. Volkswagen Rabbit acceleration.

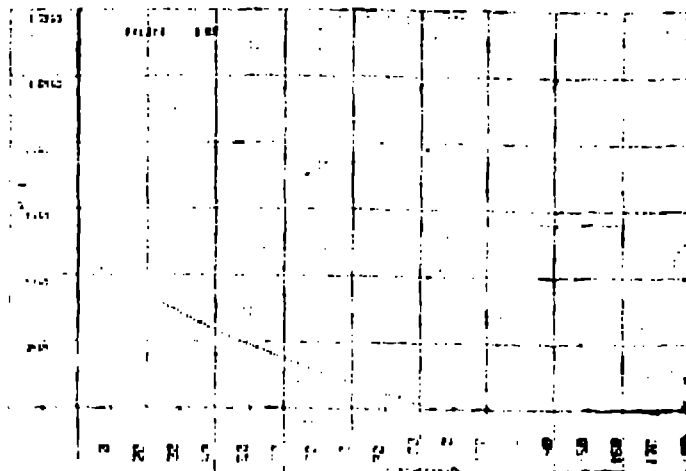

Fig. 6. Volkswagen Rabbit coast down.