

MICROCOMPUTERS

USERS MANUAL
MOTHERBOARD
KIM-4

Publication Number 6500-17

**USERS MANUAL
MOTHERBOARD
KIM-4**

OCTOBER 1976

The information in this manual has been reviewed and is believed to be entirely reliable. However, no responsibility is assumed for inaccuracies. The material in this manual is for informational purposes only and is subject to change without notice.

First Edition
© MOS TECHNOLOGY, INC. 1976
"All Rights Reserved"

**MOS TECHNOLOGY, INC.
950 Rittenhouse Road
NORRISTOWN, PA. 19401**

CHAPTER 1

INTRODUCTION

Congratulations on your purchase of a KIM-4 motherboard. You will now be able to add additional memory to your KIM system, as well as EROM, ROM, and other system components as they are introduced by MOS Technology, Inc.

Because the KIM-4 motherboard will form the heart of your microcomputer system, interconnecting all of your other system components, please take a few minutes to read this manual completely before attempting to use your KIM-4. Chapter 2 of this manual describes how to install and check out your KIM-4 motherboard. Chapter 3 contains schematics and a brief theory of operation, Chapter 4 contains your warranty information for this module, and Appendix A describes how to use the direct memory access capability incorporated in the motherboard. Appendix B contains a suggested power supply for supplying current to your KIM system.

There is one important point you should understand before using your KIM-4 motherboard. Because of the high current involved in supplying power to multiple expansion boards, MOS Technology, Inc. has designed your KIM system so that you may use a single unregulated +8v supply for all the cards which you can mount in your KIM motherboard. Do not attempt to power your KIM system through a regulated +5v supply. Each expansion module provided for the KIM system will contain its own +5v regulator which will require the +8v as input. A regulator is provided on the motherboard to feed regulated +5v to your KIM-1 microcomputer module. This regulator also works off the +8v which you supply to the motherboard. If you do not have a +8v unregulated power supply, refer to Appendix B for a schematic for such a unit.

Your KIM-4 motherboard has been carefully designed for years of uninterrupted service to you. If, for any reason, the unit should fail, follow the instructions contained in Chapter 4 to provide service for your module. We hope that the KIM-4 will be a powerful and useful addition to your KIM system.

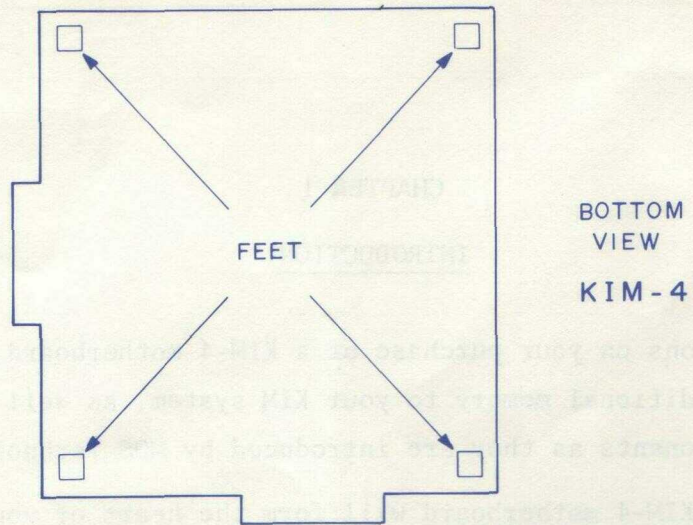

FIGURE 1
INSTALLING THE FEET

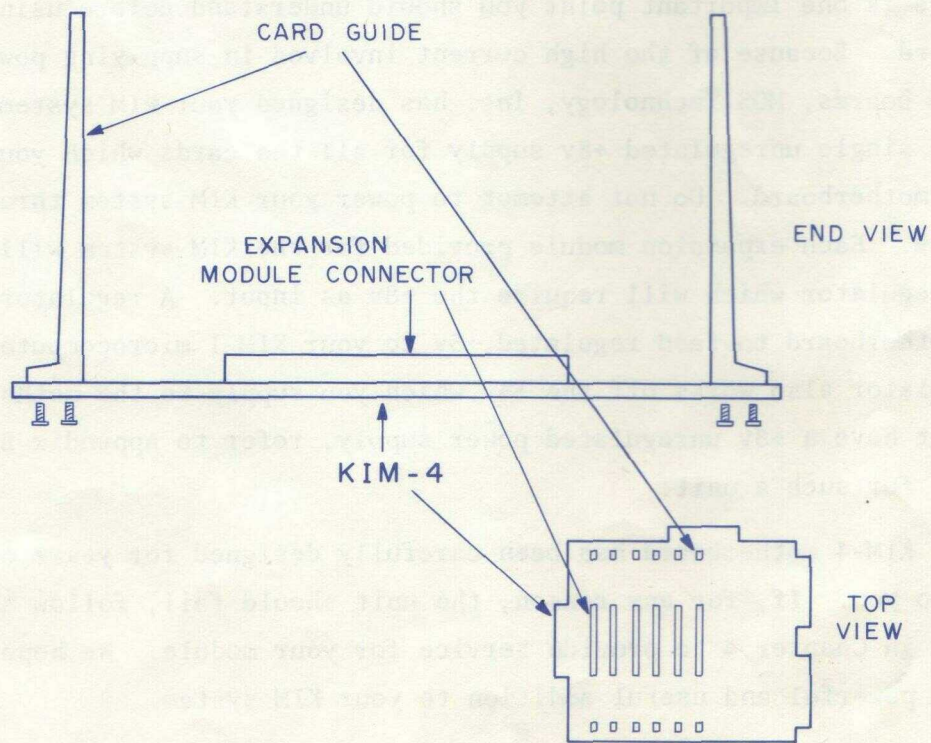

FIGURE 2
INSTALLING CARD GUIDES

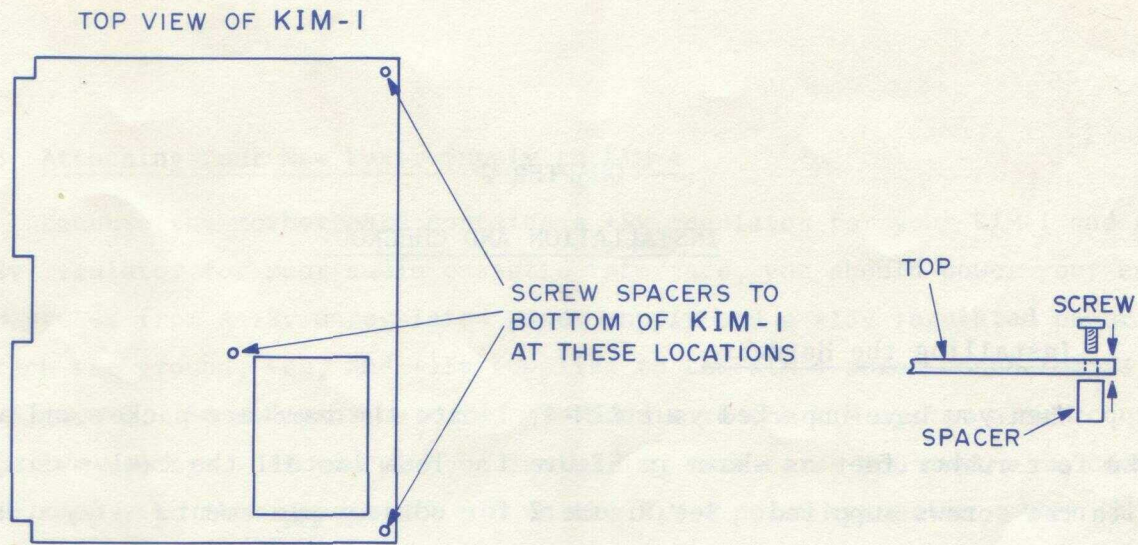

FIGURE 3
ATTACHING SPACERS TO KIM-1

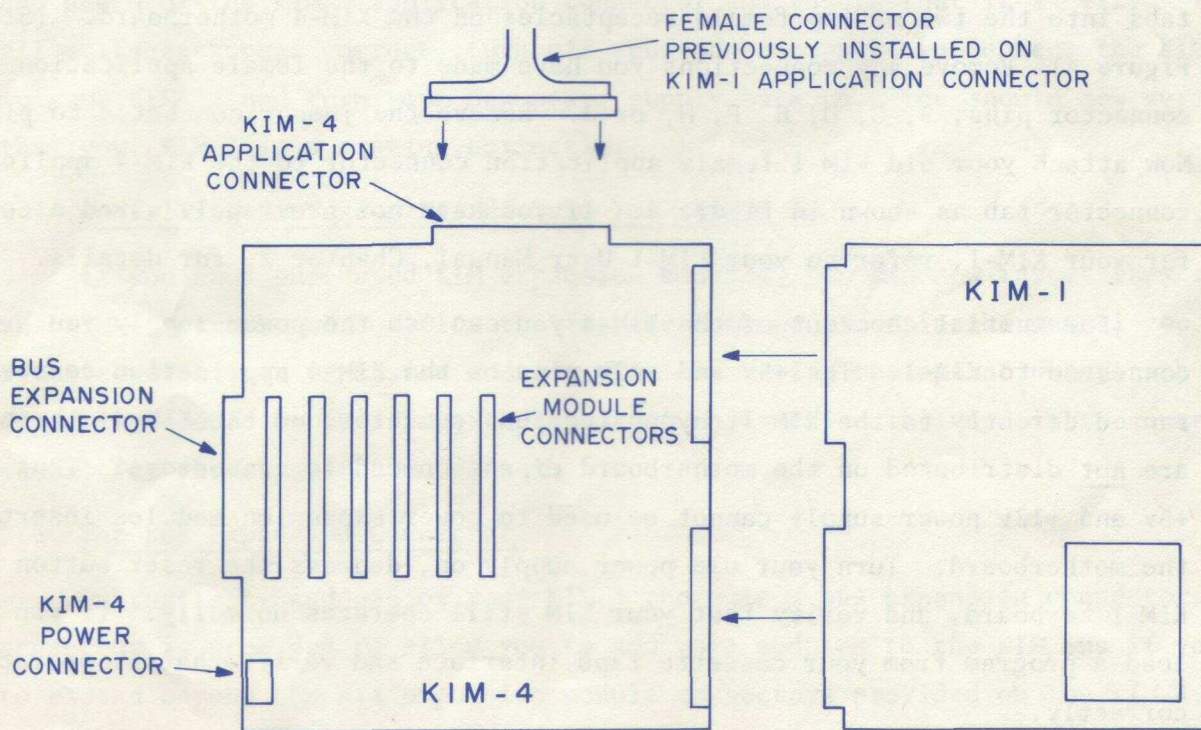

FIGURE 4
CONNECTING KIM-1 TO KIM-4

CHAPTER 2

INSTALLATION AND CHECKOUT

2.1 Installing the Hardware

When you have unpacked your KIM-4, locate the hardware packet and attach the four rubber feet as shown in Figure 1. Then install the twelve card guides with the screws supplied. See Figure 2 for correct placement. If you have one or more KIM expansion modules, put them in each card slot to assure correct placement of the guides. Three threaded spacers are provided to elevate your KIM-1. Attach them as shown in Figure 3.

2.2 Attaching KIM-4 to KIM-1 Using Your Old Power Supply

Remove any expansion cards you have placed in KIM-4 and disconnect the female connector attached to the application connector on your KIM-1. (You will also have to disconnect any connector you have mated to the KIM-1 expansion connector.) Carefully slide the KIM application and expansion connector tabs into the two mating female receptacles on the KIM-4 motherboard. (See Figure 4) Remove any connections you have made to the female application connector pins, B, C, D, E, F, H, or J. Remove the jumper connected to pin K. Now attach your old KIM-1 female application connector to the KIM-4 application connector tab as shown in Figure 4. If you have not previously wired a connector for your KIM-1, refer to your KIM-1 User Manual, Chapter 2, for details.

For initial checkout of the KIM-4 you can use the power supply you previously connected to KIM-1. The +5v and +12v pins on the KIM-4 application connector are routed directly to the KIM-1, bypassing the regulators on the KIM-4; these voltages are not distributed on the motherboard expansion module connectors. Thus your old +5v and +12v power supply cannot be used to power expansion modules inserted in the motherboard. Turn your old power supply on, depress the reset button on the KIM-1 keyboard, and verify that your KIM still operates normally. If you wish, load a program from your cassette tape interface and verify that it operates correctly.

2.3 Attaching Your New Power Supply to KIM-4

Because the motherboard contains a +5v regulator for your KIM-1 and a +12v regulator for your audio cassette interface, you should power your entire KIM system from a +8v unregulated power supply and a +15v regulated power supply. Attach the ground, +8v, and +15v supplies to the KIM-4 power connector as shown in Figure 5. Some expansion cards provided with the KIM system also require a negative voltage. If you plan on installing such cards you must also connect a -15v supply to the appropriate pin on the KIM-4 power connector. When fully expanded, your KIM system may require as much as 15A of +8v. To avoid voltage drops between your power supply and the KIM-4, make sure that you use a heavy gauge wire for the connection (No. 12 stranded wire is recommended).

Before connecting your new power supply to the KIM-4 power connector, remove your old +5v and +12v supplies from pins 1, A and N on the application connector. Disconnect the KIM-1 from your KIM-4 and turn on your new power supply. Measure the voltage between pin 1 and pin A of the KIM-4 application connector and insure that it is +5v. Now measure the voltage between pin 1 and pin N of the KIM-4 application connector and insure that it is +12v. If all voltages appear correct, turn off your power supply, re-connect the KIM-1 to your KIM-4, and turn your new power supply back on. You should now verify that your KIM-1 is operating correctly.

2.4 Installing Expansion Boards Into Your KIM-4

If you have purchased KIM expansion modules, you can now insert them in the KIM-4 motherboard. Follow the instructions provided in the manual you received with each expansion module. You can verify the operation of each expansion module by following the checkout instruction included in the owner's manual for the expansion module.

2.5 The Bus Expansion Connector

On the left-hand end of your KIM-4 there is a bus expansion connector. This connector is provided to allow you to add more modules to the KIM bus if you need to expand beyond the six expansion module connectors provided on the KIM-4.

If you have designed modules which you previously connected to the KIM-1 expansion connector, you will find that the same signals previously present on the KIM-1 expansion connector are also present on the KIM-4 bus expansion connector. The wire list provided on the KIM-4 schematic (See Chapter 3) shows the pin connections to the KIM-4 bus expansion connector. Only the lines K0 through K7, previously present on the KIM-1 application connector, are not present on the KIM-4 bus expansion connector.

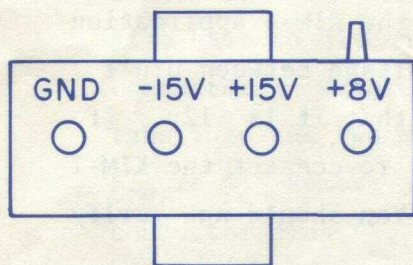

POWER CONNECTOR
CABLE
END VIEW

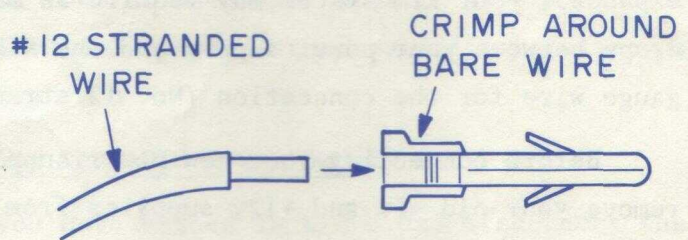

WIRING THE CONNECTOR PINS

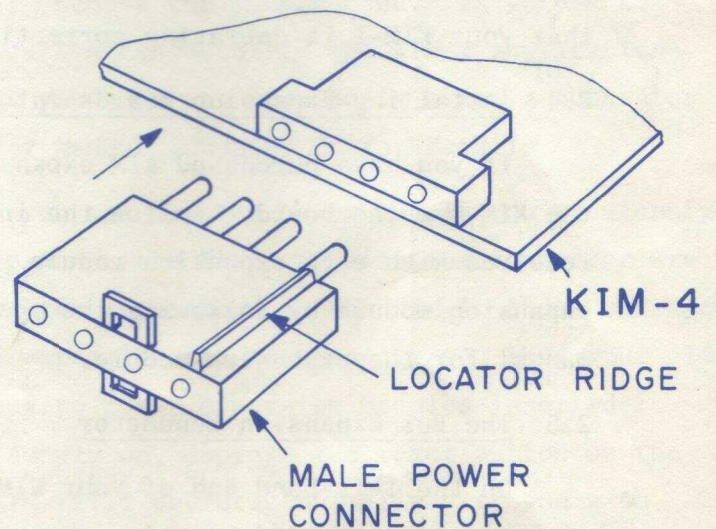

FIGURE 5
POWER CONNECTOR WIRING

CHAPTER 3

THEORY OF OPERATION

3.1 Introduction

The KIM-4 motherboard is designed to accomplish three functions. The first function is that of distributing address, data, and control lines from the KIM-1 to the expansion module connectors and the bus expansion connector. Those inter-connections are documented on the interconnection list shown on the schematic diagram. The second function is to buffer, or provide additional drive, for the expansion modules from the address and data buses. The third function is to determine whether the address present on the address bus is addressing a memory location on the KIM-1 module or the KIM-4 motherboard, and supply an appropriate signal to the decode line. The motherboard also contains regulators for the +5v and +12v supplies necessary to operate the KIM-1 and the audio cassette interface.

3.2 Buffering Circuitry

U6, U8, and U9 form a 16-bit unidirectional bus buffer for the KIM-1 address lines. These lines will normally be "on" at all times. The output of these buffers may be placed in the high impedance state by the $\overline{\text{DMA}}$ signal. More details on the use of the $\overline{\text{DMA}}$ signal are contained in Appendix A.

U2 and U1 are bidirectional bus buffers for the KIM data lines. These buffers will only be active during phase 2 of the clock timing cycle. They will also be activated only when an address between 0400 and 13FF or 2000 and FFF7 is present on the address lines. When enabled, the direction of the buffering will depend on the R/W line. During a read cycle, the buffers will enable data to travel from the motherboard to KIM-1. During a write cycle the buffers allow data to travel from the KIM-1 to the motherboard. These buffers will remain in their high impedance state in both directions when the DMA line is activated.

3.3 Address Decoding and Lockout Circuitry

Since some addresses below 2000 (hex) are located on the KIM-1 board, the data bus buffers are used to isolate KIM-1 from the motherboard whenever these addresses below 2000 are issued. This function is provided by U5, which is connected to the three high-order address lines (AB13, 14, 15). If any of those address lines go high (indicating an address above 2000), then the data bus buffers will be enabled in the appropriate direction. The data buffers will also be enabled if an address between 0400 and 13FF (indicated by the K1, K2, K3, and K4 lines) is present.

There are six locations in the memory space which have special significance in any 6502-based system. These are locations FFFA through FFFF. These locations contain the values for the interrupt vectors for the NMI, RST, and IRQ control lines. In the KIM-1 system, these interrupt vectors are stored in locations 17FA - 17FF, the six highest memory locations in KIM-1 since the three highest address lines are not decoded on KIM-1. Since the full KIM system, including the motherboard, does use all sixteen address lines, it is necessary to detect when one of these six highest addresses is issued by the processor and force the data to be read from KIM-1 rather than any memory on the motherboard. This function is provided by U7. Whenever the thirteen high-order address lines are all at logic 1, this condition is detected by U7 and the signal generated is used to disable U5. When U5 is disabled, the decode line generated as the output of U5 goes to a logic 1. This is inverted in U3 and becomes the decode enable line which is fed back to the KIM-1. The motherboard addressing is turned off and the addressing on KIM-1 is turned on, allowing the reset, NMI, and IRQ vectors to be fetched from the high six memory locations in KIM-1. Thus, even with a fully expanded KIM system, these three control vectors will still be under the control of the KIM monitor.

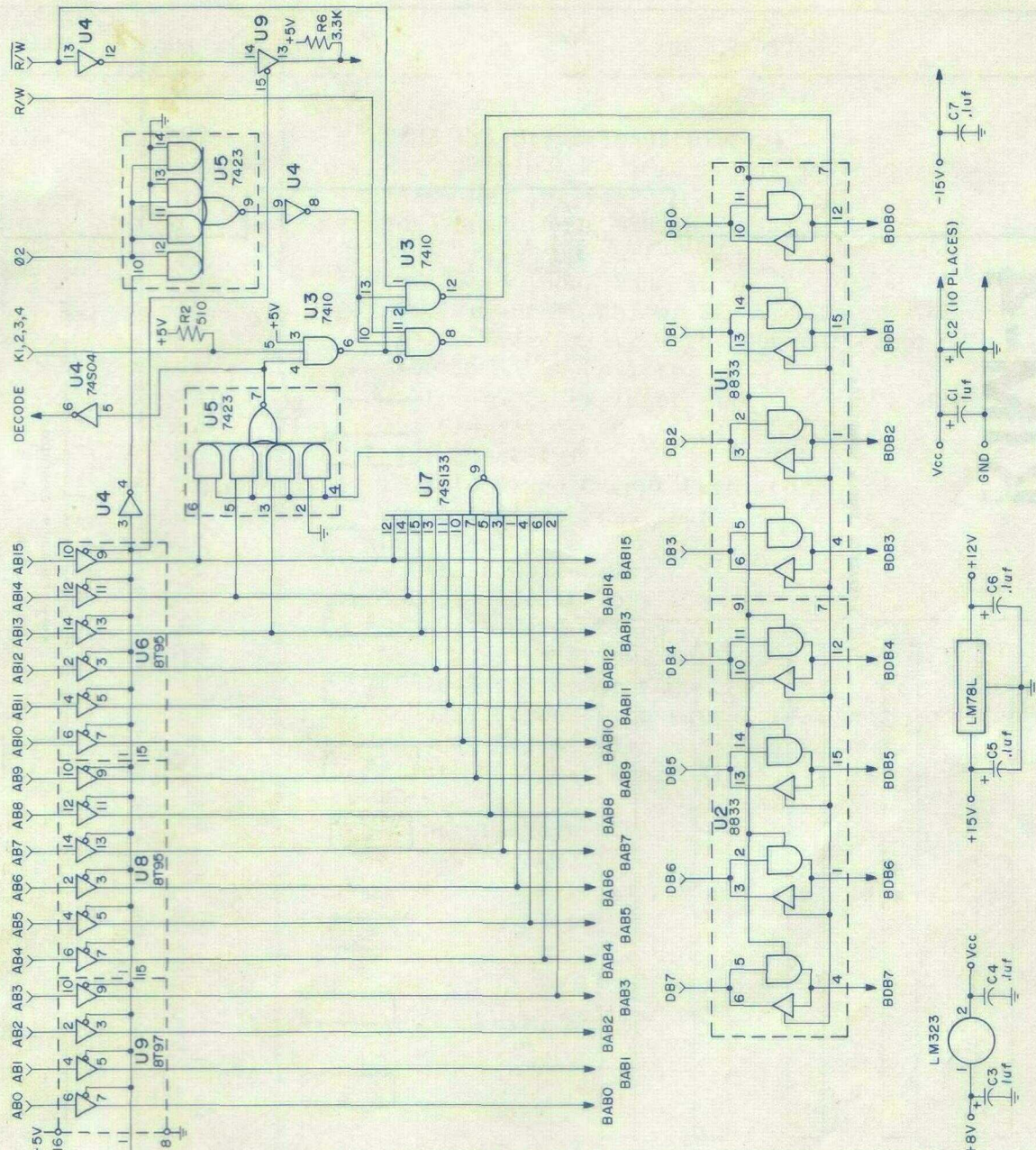

SCHEMATIC
KIM-4

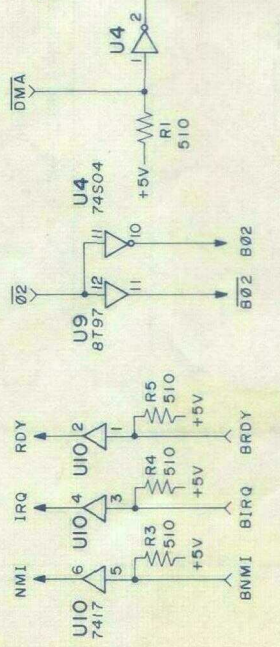

PIN NO.	FROM KIM-1 APPLICATION CONN.	EXPANSION CONN.	KIM-4 APPLICATION CONN.	EXPANSION MODULE CONNECTORS	EXTERNAL POWER CONN.
1	GND	SYNC	GND	GND (15A)	GND
2	PA3	RDY	PA3	BRDY	-15V
3	PA2	PA2	PA2	BIRQ	
4	PA1	IRQ	PA1	-15V	
5	PA4	RO	PA4	BNMI	
6	PA5	NMI	PA5	RST	
7	PA6	PA6	PA6	DB7	
8	PA7	DB7	PA7	DB8	
9	PB0	DB6	PB0	DB9	
10	PB1	DB5	PB1	DB10	
11	PB2	DB4	PB2	DB11	
12	PB3	DB3	PB3	DB12	
13	PB4	DB2	PB4	DB13	
14	PA0	DB1	PA0	DB14	
15	PB7	DB0	PB7	DB15	
16	PB5	K6	PB5	BD SEL	+15V
17	KB RO	SST OUT	KB RO	DM7A	+8V
18	KB C-F		KB C-F	+8V (15A)	
19	KB C-B		KB C-B	+5V	
20	KB C-E	Vcc	KB C-E	GND (15A)	
21	KB C-A	GND	KB C-A	GND (15A)	
22	KB C-D	GND	KB C-D	GND (15A)	
A	Vcc	ABO	Vcc	ABO	
B	K0	ABI	BIRQ	BAB0	
C	K1	AB2	BNMI	BAB1	
D	K2	AB3	RST	BAB2	
E	K3	AB4	BRDY	BAB3	
F	K4	AB5		BAB4	
G	K5	AB6		BAB5	
H	K6	AB7		BAB6	
J	DECODE	AB8	AUD IN	BAB7	
K	AUD IN	AB9	AUD OUT-L	BAB8	
L	AUD OUT-L	AB10	AUD OUT-H	BAB9	
M	+12V	AB11	AUD OUT-H	BAB10	
N	AUD OUT-H	AB12	TTY KY(+)	BAB11	
P	TTY KY(+)	AB13	TTY KY(+)	BAB12	
R	TTY PTR(+)	AB14	TTY PTR(+)	BAB13	
S	TTY KY(-)	AB15	TTY KY(-)	BAB14	
T	TTY PTR(-)	Ø2	TTY PTR(-)	BAB15	
U	KB R3	R/W	KB R3	BØ2	
V	KB C-G	R/W	KB C-G	BR/W	
W	KB R2	PLL TEST	KB R2	BØ2	
X	KB C-C	Ø2	KB C-C	+5V	
Y	KB R1	RAM	KB R1	GND (15A)	
Z					



KIM-4

EXPANSION MODULE CONNECTORS

BUS EXPANSION CONNECTOR
J4

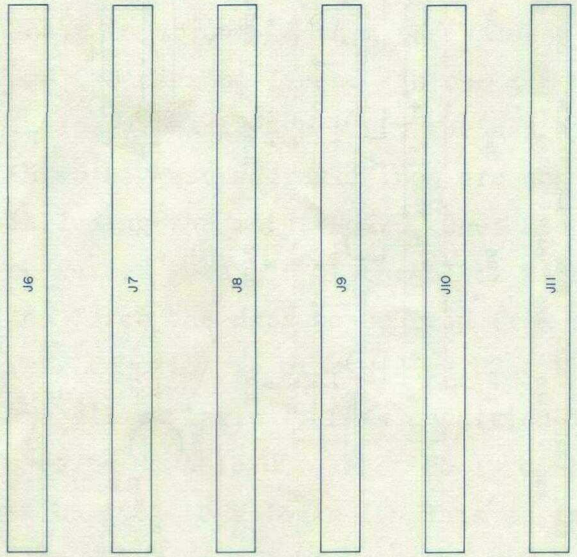

EXTERNAL POWER CONNECTOR
J5

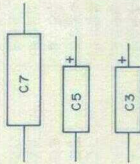

KIM-4 APPLICATION CONNECTOR
J3

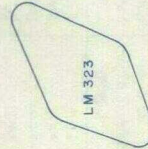
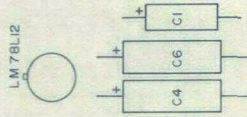
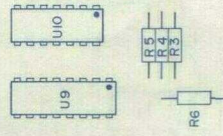

KIM-1 EXPANSION CONNECTOR
J2

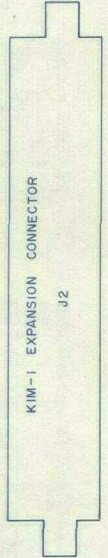

KIM-1 APPLICATION CONNECTOR
J1

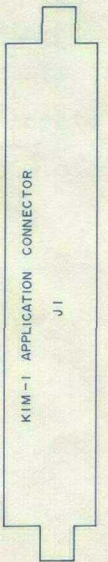

ITEM	COMPONENT NUMBER	QUANTITY	DESCRIPTION
1	U1,U2	2	8833 Tri-State Transceiver IC
2	U3	1	7410 Triple Nand IC
3	U4	1	74S04 Hex Inverter IC
4	U5	1	7423 Dual Input NOR IC
5	U6,U8	2	8T95 Tri-State Buffer IC
6	U7	1	74S133 13 Input Nand IC
7	U9	1	8T97 Tri-State Buffer IC
8	U10	1	7417 Buffer/Driver with/open collector IC
9	R1 thru R5	5	510Ω ±10%, ¼w Resistor
10	R6	1	3.3K ±10% ¼w Resistor
11	C1,C3,C5	3	1uf Capacitor
12	C4,C6,C7	3	.1uf Capacitor
13		1	LM78L12 Fixed Output Regulator
14		1	LM323 Voltage Regulator
15		1	Heat Sink
16		6	530655-6 Connectors
17		2	583458-2 Connectors
18		12	583671-1 Card Guides
19		12	Self Tapping Screws
20		1	CP-76-31004 Power Connector
21		2	#6-32x¼ Screws with nuts & lock washers
22		6	#4-40x½ Screws with nuts & star washers
23		1	Printed Circuit Board KIM-4
24		5	Rubber Pads
25		3	½ Spacers Tapped 6-32
26		3	6-32-¼ Screws

TITLE: KIM-4 PARTS LIST

SHEET 1 OF 1

DRAWING NO. 1120-0263

CHAPTER 4

WARRANTY AND SERVICE

Should you experience difficulty with your KIM-4 module and be unable to diagnose or correct the problem, you may return the unit to MOS Technology, Inc. for repair.

4.1 In-Warranty Service

All KIM series Microcomputer Modules are warranted by MOS Technology, Inc. against defects in workmanship and materials for a period of ninety (90) days from date of delivery. During the warranty period, MOS Technology, Inc. will repair or, at its option, replace at no charge components that prove to be defective provided that the module is returned, shipping prepaid, to:

KIM Customer Service Department
MOS Technology, Inc.
950 Rittenhouse Road
Norristown, Pennsylvania 19401

This warranty does not apply if the module has been damaged by accident or misuse, or as a result of repairs or modifications made by other than authorized personnel at the above captioned service facility.

No other warranty is expressed or implied. MOS Technology, Inc. is not liable for consequential damages.

4.2 Out-Of-Warranty Service

Beyond the ninety (90) day warranty period, KIM modules will be repaired for a reasonable service fee. All service work performed by MOS Technology, Inc. beyond the warranty period is warranted for an additional ninety (90) day period after shipment of the repaired module.

4.3 Policy On Changes

All KIM series modules are sold on the basis of descriptive specifications in effect at the time of sale. MOS Technology, Inc. shall have no obligation to modify or update products once sold. MOS Technology, Inc. reserves the right to make periodic changes or improvements to any KIM series module.

4.4 Shipping Instructions

It is the customer's responsibility to return the KIM series module with shipping charges prepaid to the above captioned service facility.

For in-warranty service, the KIM module will be returned to the customer, shipping prepaid, by the fastest economical carrier.

For out-of-warranty service, the customer will pay for shipping charges both ways. The repaired module will be returned to the customer C.O.D. unless the repairs and shipping charges are prepaid by the customer.

Please be certain that your KIM module is safely packaged when returning it to the above captioned service facility.

APPENDIX A

USING DMA WITH THE KIM-4

Some advanced applications involving access to high-speed peripherals such as floppy discs require the ability to stop the processor and allow another device (usually called a 'controller') to gain control of the address and data lines in order to transfer a quantity of data in or out of the memory. This is called DMA or direct memory access.

A line called $\overline{\text{DMA}}$ is bussed on the KIM-4 motherboard to provide this function. All controllers can be wire-ORed to this line. When $\overline{\text{DMA}}$ is pulled to a logic 0, the address and data busses on KIM-4 are electrically disconnected from the KIM-1, as is the BR/W line. The controller can then place its own signals on the address and data busses and manipulate the R/W line to control memory. Note that the $\phi 2$ clock line from the 6502 processor on KIM-1 is still available to provide synchronization for the controller.

The only way to halt the 6502 processor on the KIM-1 is to pull its READY line to logic 0. The processor will then halt in phase two of the next read cycle. The READY line can not be used to stop the processor during a write cycle.

Figure A-1 shows the logic necessary to interface a controller to the KIM system. Since the R/W line on KIM-4 will be disconnected from the KIM-1 during the DMA process, the DMA circuit shown in section 2.3 of the 6502 Hardware Manual cannot be used.

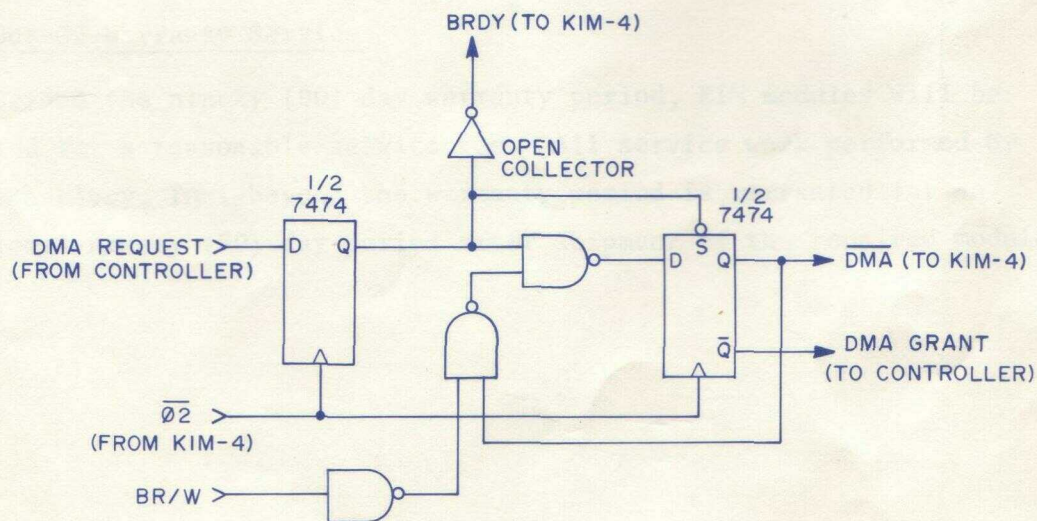

FIGURE A-1
DMA CIRCUITRY

APPENDIX B

A KIM SYSTEM POWER SUPPLY

The circuit shown in Figure B-1 will provide enough current for a fully expanded KIM system - +8v at about 15A.

Be sure to wire all components with #10 or heavier wire. A suggested transformer for T1 is the model 16-8 manufactured by Signal Transformer Company. Be sure to wire the two secondary windings in PHASE across the bridge rectifier. The .01 Ω resistor is composed of a six inch length of #22 wire.

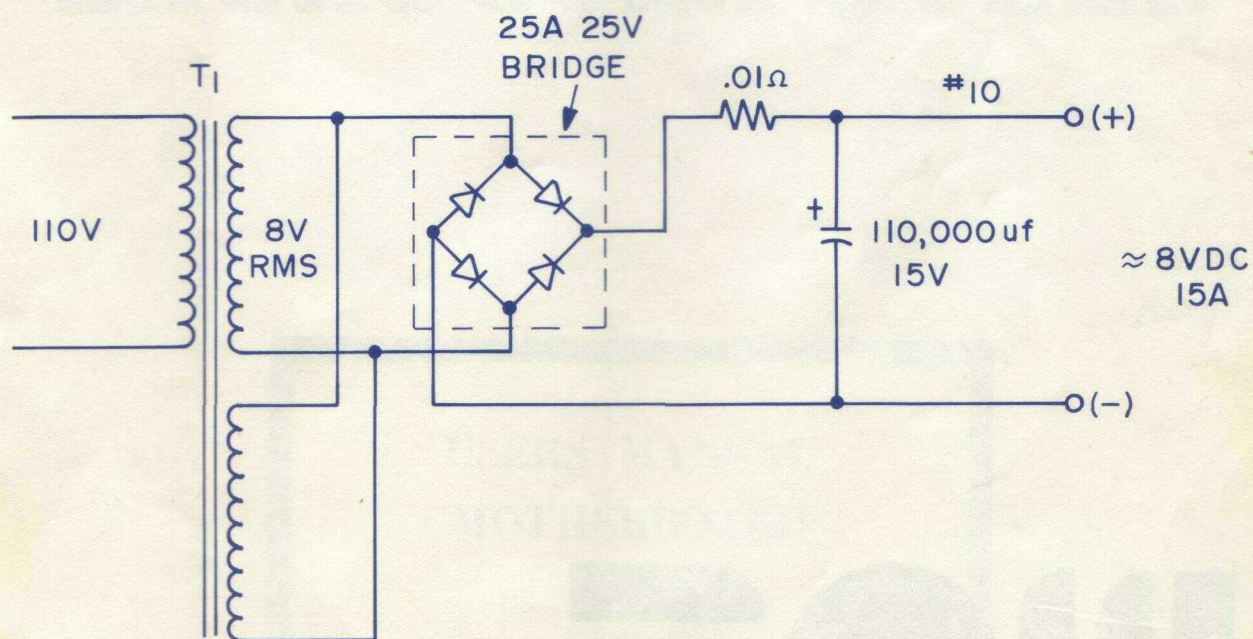
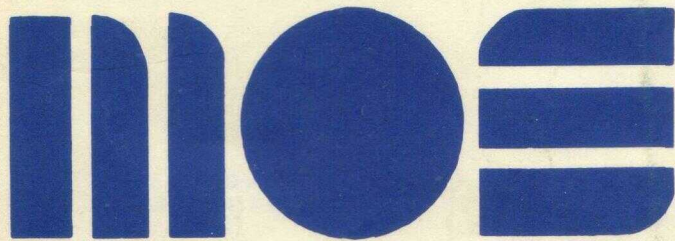

FIGURE B-1

KIM SYSTEM +8V POWER SUPPLY



MOST TECHNOLOGY, INC.

VALLEY FORGE CORPORATE CENTER
950 RITTENHOUSE ROAD NORRISTOWN, PA. 19401
